

Varenummer: 204380M24100D3T
 Beskrivelse: E+G Justerfod
 GN 43-80-M24-100-D3-T
 Note: T Uden møtrik, spændeflade i bunden

Mål

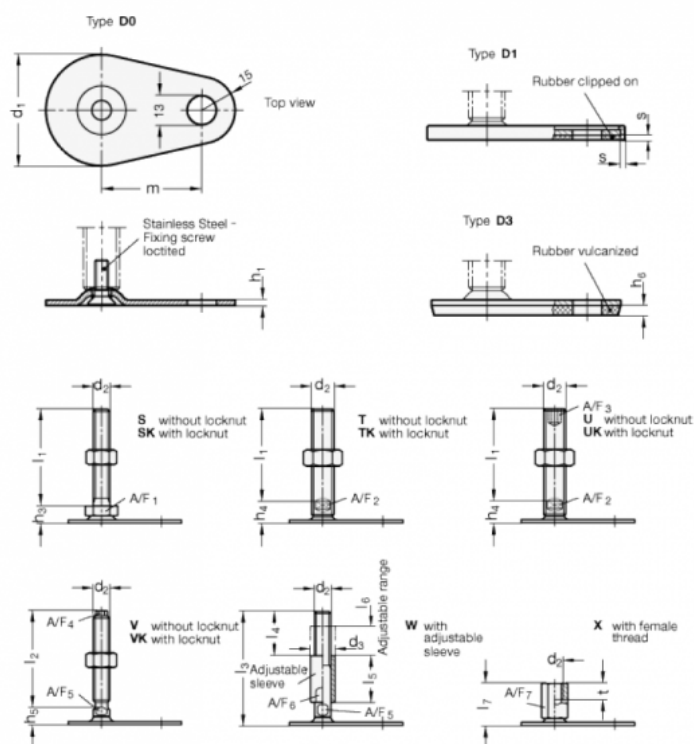

A/F2 = 19

s =

d1 = 80

d2 = M24

h1 = 3

h4 = 21

h6 = 5

l1 = 100

m = 70